

CLASSIC Series Specification

D560RGB

24V-10mm



【General description】

- RGB colorful strip
- 5050 LED with broader luminous surface
- Widely adaptable to all types of controllers, Self-encapsulated design
- High quality FPC, high thermal 3M adhesive
- With life span over 60000H
- Ta: -25~40°C; Tc: 75°C(max)
- UL/UACK/CE/ROHS/REACH certification

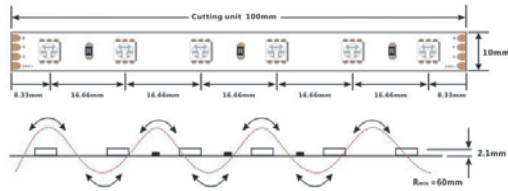

【Dimension】

Input voltage: DC24V	Max.length: 5000mm
CRI: >0	Cutting unit: 6leds/100mm
Max.power: 14.4W(1m)	LED pitch: 16.66mm
Power range: 11.5 ~14.4W(1m)	Min. bend diameter: Φ 60mm
Rated current: 0.52A(1m) /2.22A(5m)	Mounting: 3M tape
Typical Power: 12.5W(1m) /53.3W(5m)	Copper foil: 2oz
tape IP: IP20/IP65/IP67	
On-off times: 10000 (test times)	
Warranty: 5 years indoor /3 years outdoor	

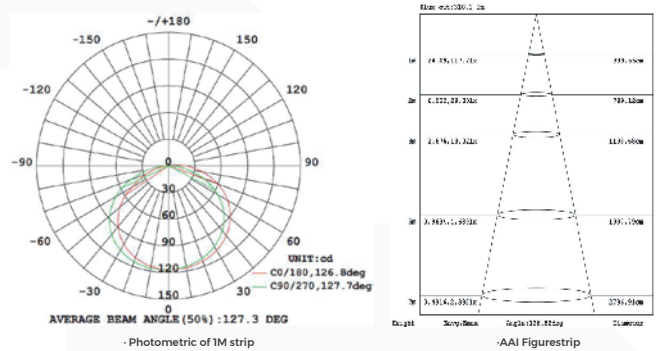

【Photo-electric Parameters】

CRI	Color	Wavelength	Lumen(lm)	lm/W	Energy efficiency class
0	Red	625	108	/	/
0	Green	525	279	/	/
0	Blue	470	55	/	/
0	RGB	/	416	/	/

- 1.The tolerance of output data can be vary up to 10%.
- 2.the output data tested according to IES TM-30-15.
- 3.the output data is based on IP20/1merter, data of 5m in only for reference.
- 4.IP protection process leads changes to size, CCT and luminous flux.

[IP process information]



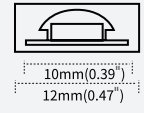
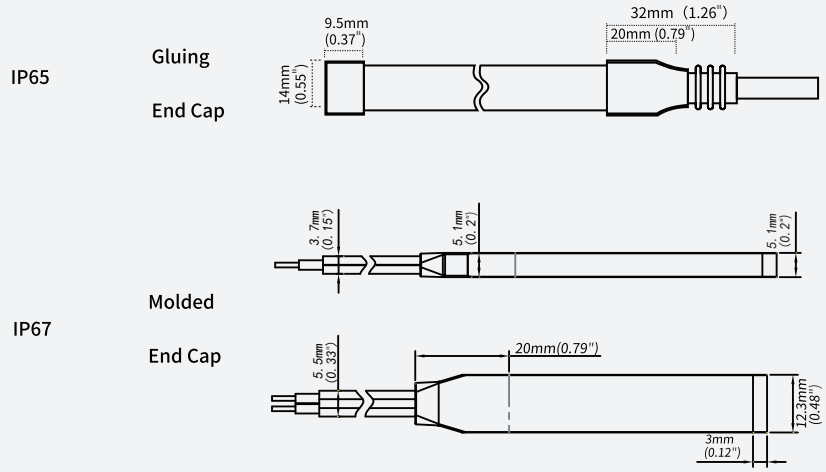

ET

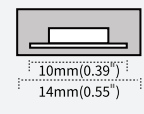
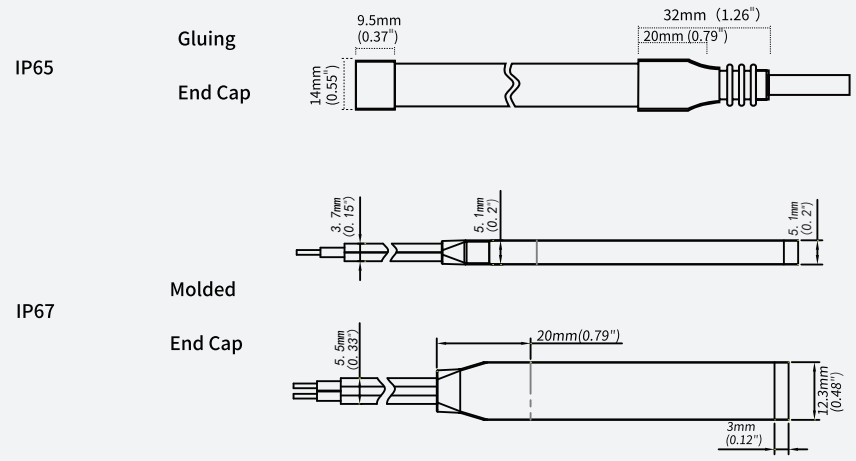

EF









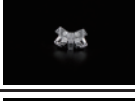

【IP Process Parameters】

IP Process	Picture	Picture description	Size	optional CCT/color for finished product	lumen output rate
NO	 NO/IP20	No proof	10mm*1.5mm	RGB	100%
NA	 NANO/IP65	Nano-proof	10mm*1.6mm	RGB	98%
ET	 ET/IP67	Extrusion tube	12 mm*4.8mm	RGB	88%
EF	 EF/IP67	Extrusion filling	12 mm*5mm	RGB	86%

【Accessories Information】

• Connector Accessories

Name	Picture	Code	coding	description
Connector for wire and FPC		94-42-621040001	TXB410-NOGA	10mm width, 4PIN connector of wire and FPC, suitable for RGB color strip, NO/NA
Connector for FPC and FPC		94-42-621040002	TBB410-NOGA	10mm width, 4PIN connector of FPC and FPC, suitable for RGB color strip,NO/NA
Fixed Clip		94-02-00-0003	FSW10SA	Silicone clip, screw: PA 3*8mm, suitable for 10mm FPC,EF/ET strip
Silicone Plug Kit		94-02-00-0046	DT10EA-A	Silicone plug kit is suitable for 10mm board width, ET/EF series silicone extrusion light strip
Silicone stopper kit		94-02-00-0047	DW10EA-A	Silicone tail plug kit is suitable for 10mm board width, ET/EF series silicone extrusion light strip
Mounting groove		94-02-00-0025	CVT10EA-14100100	Transparent PVC mounting groove,suitable for 10mm FPC,silicone extruded EF/ET strip
Stopper glue		94-16-03010001	AS-PG-0003	Silicone gel,suitable for ET/EF/EG waterproof LED strip
RGB RF Controller		402-01-000000-00003	CR3-GBA	Input voltage: 12-48VDC Maximum loaded current: 6A*3CH Max 18A Maximum loaded power: 216W/432W@12V/24V 648W/864W@36V/48V
RGB RF Remote		402-02-000000-00003	CK4-GBA	Working voltage : 3VDC Remote Distance : 30m Output Singal: RF2.4GHz

【Packing】

Colors brand package

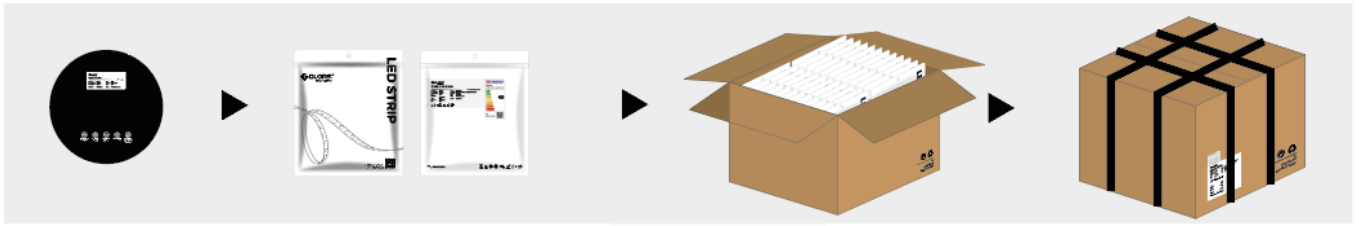

General customized package

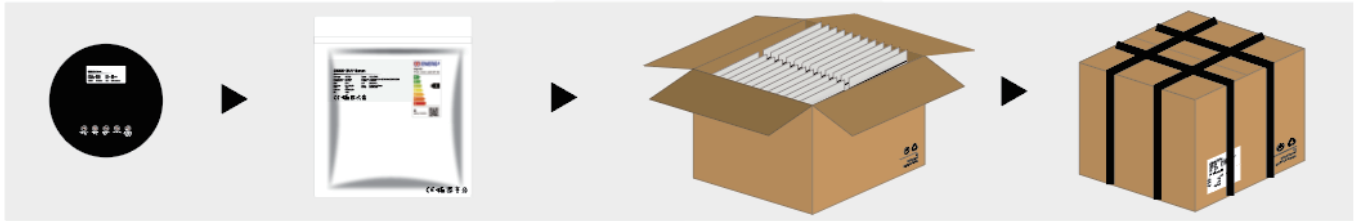

IP Process	Product size(mm)	Product quantity (m/reel)	Product quantity (m/case)	Product net weight(kg)	Net weight per box(kg)	Gross weight(kg)	Package size (cm)
NO	5000*10*2.1	5	250	0.15	7.5	8.625	41*41*26
NA	5000*10*2.1	5	250	0.153	7.65	8.798	41*41*26
ET	5000*12*4.8	5	200	0.5	20	23	41*41*26
EF	5000*12*5.0	5	200	0.567	22.68	26.082	41*41*26

Remark: data with 10% tolerance

· Engineering packaging of ET(IP67)/EF(IP67)

(free-soldering end caps with 40 cover per box could be ordered separately if needed)

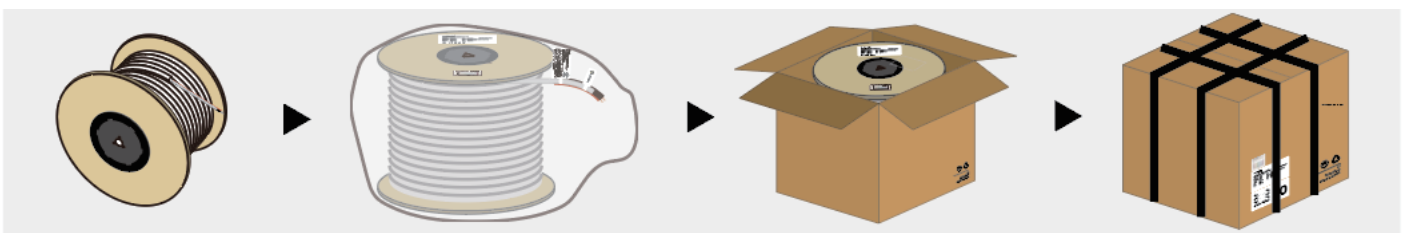

· Engineering packaging of NO(IP20)/NA(IP65).



IP Process	Product size(mm)	Product quantity (m/reel)	Product quantity (m/case)	Product net weight(kg)	Net weight per box(kg)	Gross weight(kg)	Package size (cm)
NO	5000*10*2.1	50	500	1.5	15	17.25	41*41*26
NA	5000*10*2.1	50	500	1.53	15.3	17.595	41*41*26
ET	5000*12*4.8	50	100	5.1	10.2	11.73	25.5*25.5*26
EF	5000*12*5.0	50	100	5.72	11.44	13.156	25.5*25.5*26

Remark data with 10% tolerance

【Precautions】

- Please drive the led strip with 24VDC isolated power, and the ripple of the constant voltage source should be less than 5%.
- Please do not bend the strip into an arc with a diameter less than 60mm to ensure the longevity and reliability.
- Do not fold it in case any damage of LED beads.
- Do not pull the power wire hard to ensure the longevity.Any Crash may damage the LED light is prohibited.
- Please make sure the wire is connected to the anode and cathode correctly. The power output should be consistent with the voltage of the strip to avoid damage.
- LED lights should be stored in dry, sealed environment. Please only unpack it before usage. Ambient temperature: -25 C~40 C.Storage temperature: 0 C~60 C.Please use the strips without waterproof within indoor environment with humidity less than 70%.
- Please be careful during operation. Do not touch the AC power supply in case of electric shock.
- Please leave at least 20% power for the power supply during using to ensure there is enough power supply to drive the product.
- Do not use any acid or alkaline adhesives to fix the product (e.g.: glass cement).
- Do not scratch the product when IP processof the product is NA. Ultraviolet rays will damage the nano-layers on the product and seriously affect the life of the product.